

8MP Network IR Fixed Dome Camera

IPC3618SR3-DPF28(40)



Key Features

Optics

- Day/night functionality
- Smart IR , up to 30m (98ft) IR distance
- Optical glass window with higher light transmittance
- IR anti-reflection window to increase the infrared transmittance
- 2D/3D DNR (Digital Noise Reduction)
- Up to 120dB WDR (Wide Dynamic Range)

Compression

- Ultra 265, H.264, MJPEG
- Triple streams
- 9:16 corridor format

Network

- ONVIF Conformance

Structure

- Wide temperature range: -30°C ~ 60°C (-22°F ~ 140°F)
- Wide voltage range of ±25%
- IP67
- 3-Axis

Specifications

	IPC3618SR3-DPF28	IPC3618SR3-DPF40			
Camera					
Sensor	1/2.5", 8.0 megapixel, progressive scan, CMOS				
Lens	2.8mm@F2.0	4.0mm@F2.0			
Angle of view (H)	118.1°	91.6°			
Angle of view (V)	64.0°	47.2°			
Angle of view (O)	153.5°	112.7°			
DORI Distance	Lens (mm)	Detect (m)	Observe (m)	Recognize (m)	Identify (m)
	2.8	50.4	20.2	10.1	5.0
	4.0	72	28.8	14.4	7.2
Adjustment Range	Pan: 0° ~ 360°		Tilt: 0° ~ 90°		Rotation: 0° ~ 360°
Shutter	Auto/Manual, 1 ~ 1/100000s				
Minimum Illumination	Colour: 0.05Lux (F2.0, AGC ON) 0Lux with IR				
Day/Night	IR-cut filter with auto switch (ICR)				
Digital noise reduction	2D/3D DNR				
S/N	>52dB				
IR Range	Up to 30m (98ft) IR range				
Defog	Digital Defog				
WDR	120dB				
Video					
Video Compression	Ultra 265, H.264, MJPEG				
H.264 code profile	Baseline profile, Main Profile, High Profile				
Frame Rate	Main Stream: 8MP (3840*2160), Max 20fps; Sub Stream: 1080P (1920*1080), Max 30fps; Third Stream: D1 (720*576), Max 30fps				
HLC	Supported				
BLC	Supported				
9:16 Corridor Mode	Supported				
OSD	Up to 8 OSDs				
Privacy Mask	Up to 8 areas				
ROI	Up to 8 areas				
Motion Detection	Up to 4 areas				

Network	
Protocols	IPv4, IGMP, ICMP, ARP, TCP, UDP, DHCP, RTP, RTSP, RTCP, DNS, DDNS, NTP, FTP, UPnP, HTTP, HTTPS, SMTP, SSL, QoS
Compatible Integration	ONVIF (Profile S, Profile T), API
Interface	
Network	10M/100M Base-TX Ethernet
General	
Power	DC 12V±25%, PoE (IEEE 802.3af)
	Power consumption: Max 5.5W
Dimensions (Ø x H)	Ø126 x 94mm (Ø5.0" x 3.7")
Weight	0.45kg (0.99lb)
Operating Conditions	-30°C ~ 60°C (-22°F ~ 140°F), Humidity: ≤95% RH (non-condensing)
Ingress Protection	IP67

Dimensions

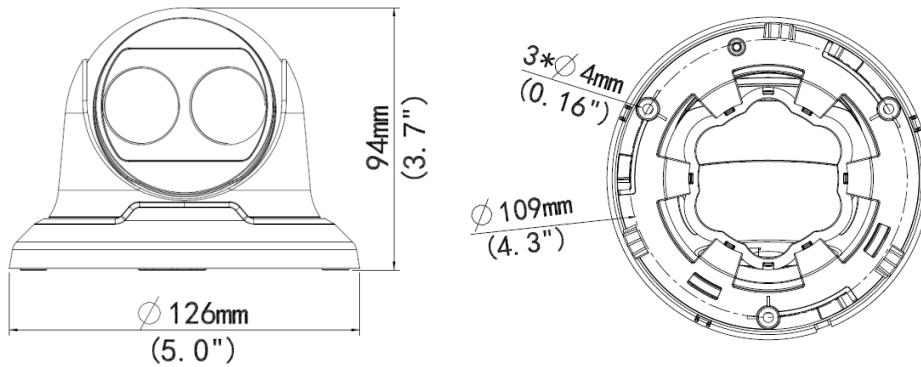

Zhejiang Uniview Technologies Co., Ltd.

Building No.10, Wanlun Science Park, Jiangling Road 88, Binjiang District, Hangzhou, Zhejiang, China (310051)

Email: overseasbusiness@uniview.com; globalsupport@uniview.com

<http://www.uniview.com>

©2019 Zhejiang Uniview Technologies Co., Ltd. All rights reserved.

*Product specifications and availability are subject to change without notice.